

FESTOOL

OF 2200 EB
Plunge Router



Plunge Router Supplemental User's Manual

 **WARNING** *To reduce the risk of serious injury, read and understand all safety precautions and instructions in this manual before using this tool.*

Limited Warranty

30 Day Money Back Guarantee

We are so confident that you will thoroughly enjoy our tools, that we offer a 30 day money back guarantee. If you are not

completely satisfied, your full purchase price will be refunded, excluding all freight charges.

1+2 Limited Warranty

Festool USA offers a 3-year limited warranty, one of the longest in the industry. This warranty is valid on the pre-condition that the tool is used and operated in compliance with the Festool

operating instructions. Festool USA warrants that the specified tool will be free from defects in materials and workmanship for a term of 3 years from the date of purchase.

Conditions of 1+2 Limited Warranty

You are entitled to a free extended limited warranty (1 year + 2 years = 3 Years) for your Festool power tool. Festool USA is responsible for all shipping costs during the first year of the warranty. During the second and third year of the warranty, the customer is responsible for shipping the tool to Festool. Festool will pay for return shipping to the customer using UPS Ground Service. All warranty service is valid 3 years from the date of purchase on your receipt or invoice.

Excluded from the coverage under this warranty are: normal wear and tear, damages caused by misuse, abuse, or neglect; damage caused by anything other than defects in material and workmanship. This warranty does not apply to accessory items such as circular saw blades, drill bits, router bits, jigsaw blades, sanding belts, and grinding wheels. Also excluded are "wearing parts," such as carbon brushes, lamellas of air tools, rubber collars and seals, sanding discs and pads, batteries, and Festool gear (hats and t shirts).

The obligations of Festool USA in its sole discretion under this warranty shall be limited to repair or replacement or a refund of the purchase price for any Festool portable power tool that is found to have a defect in materials or workmanship during the

warranty period. FESTOOL USA SHALL NOT BE LIABLE FOR ANY CONSEQUENTIAL, INCIDENTAL OR SPECIAL DAMAGES REGARDLESS OF THE THEORY OF LAW ON WHICH THE CLAIM IS BASED. ALL WARRANTIES IMPLIED BY STATE LAW, INCLUDING THE IMPLIED WARRANTIES OR MERCHANTABILITY AND FITNESS FOR A PARTICULAR PURPOSE ARE HEREBY LIMITED TO THE DURATION OF THREE YEARS.

Some states in the U.S. and some Canadian provinces do not allow the limitations on how long an implied warranty lasts, so the above limitation may not apply to you. This warranty gives you specific legal rights, and you may also have other rights that vary from state to state in the U.S. and from province to province in Canada.

With the exception of any warranties implied by state or province law as limited above, the foregoing express limited warranty is exclusive and in lieu of all other warranties, guarantees, agreements, and similar obligations of Festool USA. Festool USA makes no other warranty, express or implied, for Festool portable power tools. No agent, representative, distributor, dealer, or employee of Festool USA has the authority to increase or otherwise change the obligations or limitations of this warranty.

Repairs

If your Festool power tools require repair, you must contact our Service Department at (800) 554-8741 for authorization and address details. No collect shipments will be accepted. No Festool

hats, t-shirts or other wearables may be returned. Also contact our Service Department at the telephone number listed above if you have any questions about warranty claim procedures.

Returns

If you need to return your Festool tools for any reason, please return it to the dealer from which you originally bought the tool.

Liability Statement

This product has been built to the high standards of Festool. Please do not attempt to operate or repair this equipment without adequate training. Any use, operation, or repair in contravention of this document is at your own risk. By acceptance of this system you hereby assume all liability consequent to your use or

misuse of this equipment. Festool USA assumes no liability for incidental, special, or consequential damage of any kind. Equipment specifications, applications, and options are subject to change at the sole discretion of Festool USA without notice.

Proprietary Notice

All drawings and information herein are the property of Festool, TTS Tooltechnic Systems AG & Co. KG. All unauthorized use and reproduction is prohibited.

Written and Illustrated by Rick Christopherson.

© 2008 TTS Tooltechnic Systems AG & Co. KG

All rights reserved. Printed in the United States of America and Germany.

Festool USA is a division of Tooltechnic Systems, LLC.

Festool is a trademark and service mark of TTS Tooltechnic Systems AG & Co. KG

Plug-It and Systainer are registered trademarks of TTS Tooltechnic Systems AG & Co. KG

www.festoolusa.com

Contents

Limited Warranty	2	Basic Operation	9
30 Day Money Back Guarantee	2	Changing Router Bits	9
1+2 Limited Warranty	2	Changing Collets	9
Conditions of 1+2 Limited Warranty	2	Setting the Plunge Depth	10
Repairs	2	Offset from a Surface	10
Returns	2	By Router Bit Profile	10
Liability Statement	2	Changing Baseplates	11
Proprietary Notice	2	Installing Template Guides and Chip Deflector ..	11
About This Manual	3	Basic Routing	12
Tool Symbols	3	Feed Direction Rules	12
General Power Tool Safety Warnings	4	Fixed Depth Routing	12
Work Area Safety	4	Fixed Depth Using the Turret Latch	13
Electrical Safety	4	Plunge Routing	13
Personal Safety	4	Plough Cuts	13
Power Tool Use and Care	4	Using a Template Guide	14
Service	5	Advanced Routing Techniques	14
Specific Safety Rules for Routers	5	Multi-pass Cuts	14
Respiratory Exposure Safety Warnings	5	Multi-depth Ploughing	14
Tool Description	5	Multi-depth Profiles	15
Technical Specifications	5	Multi-position (horizontal) Profiles	15
Intended Use	6	Pre-cutting Dovetails and Keyways	15
Overview	6	Precision Routing	16
Power Controls	7	Tips for Successful Routing	17
Router Speed and Feed Rate	7	Chipping and Tearout	17
Dust Collection	7	Chatter	17
Plunge Components	8	Climb-Cut Routing	18
Depth Stop Turret	8	Accessories	19
Turret Latching Lever	8	Guide Rail Attachment	19
Fine Adjustment Dial	8	Edge Guide	20
Plunge Depth Gauge	8	System Container	21
Plunge Lock Knob	8	Troubleshooting	22
Depth Stop Locking Lever and Post	8	Maintenance	23
		Routine Maintenance	23

About This Manual

Save These Instructions

It is important for you to read and understand this manual. The information it contains relates to protecting YOUR SAFETY and PREVENTING PROBLEMS. The symbols below are used to help you recognize this information.



WARNING!

Indicates a potentially hazardous situation which, if not avoided, could result in death or serious injury.



CAUTION!

Indicates a potentially hazardous situation which, if not avoided, could result in minor or moderate injury.



NOTICE:

Indicates a potential situation which, if not avoided, can result in property damage or damage to the tool.



Note:

Indicates information, notes, or tips for improving your success using the tool.

Tool Symbols

V	Volts
W	Watts
Hz	Hertz
~	Alternating Current (AC)
n _o	No-load Speed
∅	Diameter
	Class II Double Insulated

General Power Tool Safety Warnings



WARNING! Read all safety warnings and instructions. Failure to follow the warnings and instructions may result in electric shock, fire, and/or serious injury.

Save all warnings and instructions for future reference.

Work Area Safety

- ▶ **Keep your work area clean and well lit.** Cluttered or dark work areas invite accidents.
- ▶ **Do not operate power tools in explosive atmospheres, such as in the presence of flammable liquids, gases, or dust.** Power tools create sparks which may ignite the dust or fumes.
- ▶ **Keep children and bystanders away while operating a power tool.** Distractions can cause you to lose control.

Electrical Safety

- ▶ **Power tool plugs must match the outlet. Never modify the plug in any way. Do not use any adapter plugs with earthed (grounded) power tools.** Unmodified plugs and matching outlets will reduce risk of electric shock.
- ▶ **Avoid body contact with earthed or grounded surfaces such as pipes, radiators, ranges and refrigerators.** There is an increased risk of electric shock if your body is earthed or grounded.
- ▶ **Do not expose power tools to rain or wet conditions.** Water entering a power tool will increase the risk of electric shock.
- ▶ **Do not abuse the cord. Never use the cord for carrying, pulling, or unplugging the power tool. Keep cord away from heat, oil, sharp edges or moving parts.** Damaged or entangled cords increase the risk of electric shock.
- ▶ **When operating a power tool outdoors, use an extension cord suitable for outdoor use.** Use of a cord for outdoor use reduces the risk of electric shock.
- ▶ **If operating a power tool in a damp location is unavoidable, use a ground fault circuit interrupter (GFCI) protected supply.** Use of a GFCI reduces the risk of electric shock.
- ▶ **Never use an extension cord that is damaged, including cuts, exposed wires, or bent/missing prongs.** Damaged extension cords increase the risk of fire or electric shock.
- ▶ **Use only extension cords rated for the purpose.**
- ▶ **Use only extension cords rated for the amperage of this tool and the length of the cord.** Using too small of an extension cord can cause the cord to overheat.

Extension Cord Ratings	
Cord Length	Size (AWG)
<50 Ft.	14
50-100 Ft.	12
>100 Ft.	Not recommended

Personal Safety

- ▶ **Stay alert, watch what you are doing, and use common sense when operating a power tool. Do not use a power tool while tired or under the influence of drugs, alcohol, or medication.** A moment of inattention while operating power tools may result in serious personal injury.
- ▶ **Use personal protective equipment. Always wear eye protection.** Protective equipment such as dust mask, non-skid safety shoes, hard hat, or hearing protection used for appropriate conditions will reduce personal injuries.
- ▶ **Prevent unintentional starting. Ensure the switch is in the off-position before connecting to power source, picking up, or carrying the tool.** Carrying power tools with your finger on the switch or energizing power tools that have the switch on invites accidents.
- ▶ **Remove adjusting key or wrench before turning the power tool on.** A wrench or a key that is left attached to a rotating part of the tool may result in personal injury.
- ▶ **Do not overreach. Keep proper footing and balance at all times.** This enables better control of the tool in unexpected situations.
- ▶ **Dress properly. Do not wear loose clothing or jewelry. Keep your hair, clothing, and gloves away from moving parts.** Loose clothes, jewelry, or long hair can be caught in moving parts.
- ▶ **If devices are provided for the connection of dust extraction and collection facilities, ensure these are connected and properly used.** Use of dust collection can reduce dust-related hazards.
- ▶ **Always wear safety glasses complying with ANSI Z87.1.** Ordinary glasses are not proper protection.

Power Tool Use and Care

- ▶ **Do not force the power tool. Use the correct power tool for your application.** The correct power tool will do the job better and safer at the rate for which it is designed.
- ▶ **Do not use the power tool if the switch does not turn it on and off.** Any power tool that cannot be controlled with the switch is dangerous and must be repaired.
- ▶ **Disconnect the plug from the power source before making any adjustments, changing accessories, or storing the tool.** Such preventive safety measures reduce the risk of starting the tool accidentally.
- ▶ **Store idle tools out of reach of children and do not allow persons unfamiliar with the power tool or these instructions to operate the power tool.** Power tools are dangerous in the hands of untrained users.
- ▶ **Maintain power tools. Check for misalignment or binding of moving parts, breakage of parts and any other condition that may affect the power tool's operation. If damaged, have the power tool repaired before use.** Many accidents are caused by poorly maintained power tools.
- ▶ **Keep cutting tools sharp and clean.** Properly maintained tools with sharp cutting edges are less likely to bind and are easier to control.

- ▶ **Use the power tool, accessories, and tool bits etc. in accordance with these instructions, taking into account the working conditions and the work to be**

performed. Use of the power tool for operations different from those intended could result in a hazardous situation.

- ▶ **To reduce the risk of serious injury, never alter or misuse the power tool.**

Service

- ▶ **Have your power tool serviced by a qualified repair person using only identical replacement parts.** This

will ensure that the safety of the power tool is maintained.

Specific Safety Rules for Routers

- ▶ **Hold the tool by the insulated gripping surfaces when performing an operation where the cutting tool may contact hidden wiring or its own cord.** Contact with a “live” wire will make the exposed metal parts of the tool “live” and shock the operator.
- ▶ **Use clamps or another practical way to secure and support the workpiece to a stable platform.** Holding the work by hand or against your body leaves it unstable and may lead to loss of control.
- ▶ **This tool is intended for router bits not to exceed 89mm (3.5 inches).** Using too large of a router bit will result in the router bit striking the base of the tool, and may also lead to a loss of control.
- ▶ **The router bit shank must fit the size of the collet.** Using a router bit that cannot be firmly gripped by the collet will result in the router bit coming loose, and may result in serious personal injury.
- ▶ **Always make sure the work surface is free from nails and other foreign objects.** Cutting into foreign objects can cause the router bit and/or the object to break apart and strike the operator.
- ▶ **Keep both hands on the router handles during operation.** Firmly controlling the router reduces the risk for loss of control and injury.
- ▶ **NEVER hold the piece being cut in your hands or across your leg.** It is important to support the work properly to minimize body exposure or loss of control.
- ▶ **Keep hands and body away from the cutting area or below the router base.**
- ▶ **Before using the router, make sure the collet nut and any other adjustment devices are securely tightened.** A loose adjustment device can unexpectedly shift, causing loss of control, and loose rotating components can be violently thrown.
- ▶ **Never start the tool when the bit is engaged in the workpiece.** The cutting bit may grab and cause loss of control.
- ▶ **Never use dull or damaged router bits.** Damaged bits may break during use, and dull bits require additional force to operate, which may cause the bit to break or a loss of control.
- ▶ **Never operate the router with the cutting tool engaged in the workpiece without locking the plunge lock knob.** Unexpected changes in cutting depth can result in a loss of control.
- ▶ **Do not set the router down until the motor has come to a complete stop.** The exposed spinning bit can cause serious injury or cause the router to move unexpectedly.
- ▶ **To reduce the risk of burn injury, do not touch the router bit immediately after use.** The router bit may get hot during use.
- ▶ **Always unplug the tool before changing bits or making adjustments.** Failure to do so can result in the tool starting unexpectedly.

Respiratory Exposure Safety Warnings

Substantial or repeated inhalation of dust and other airborne contaminants, in particular those with a smaller particle size, may cause respiratory or other illnesses. Various dusts created by power sanding, sawing, grinding, drilling and other construction activities contain chemicals or substances known (to the State of California and others) to cause cancer, birth defects or other reproductive harm. Some examples of these chemicals/substances are:

- ▶ lead from lead-based paints;
- ▶ crystalline silica from bricks, cement, and other masonry products;

- ▶ arsenic and chromium from chemically-treated lumber; and
- ▶ some wood dusts, especially from hardwoods, but also from some softwoods such as Western Red Cedar.

The risk from these exposures varies, depending on how often you do this type of work. To reduce your exposure to these chemicals: work in a well ventilated area and use a properly functioning dust extraction system. When the inhalation of dust cannot be substantially controlled, i.e., kept at or near the ambient (background) level, the operator and any bystanders should wear a respirator approved by NIOSH for the type of dust encountered.

Tool Description

Technical Specifications

Power Consumption	15 amps @ 120 volts
Motor Speed	10,000 – 22,000 RPM (no load)
Plunge Range	80 mm (3.1")
Fine Height Adjustment	20 mm (0.8")

Maximum Bit Diameter	89 mm (3.5")
Collet Nut Size	M22 x 1
Weight	7.8 kg (17.2 lbs)

All metric dimensions are controlling.

Intended Use

The OF 2200 EB router is designed exclusively for machining of wood, wood-like materials, and plastics. The router may also be used for machining aluminum and plasterboard when an appropriate router bit is installed. All applications beyond this are regarded as improper use. The tool should not be altered or used for any other

purpose other than as specified in these operating instructions. Using the tool in contravention to this manual may lead to injury and will void your warranty. The user shall be responsible and liable for accidents, injuries, and property damage resulting from misuse or abuse of this tool.

Overview



Item	Name or Description	Ref. Page(s)
A	Guide Rod Clamping Knob	19, 20
B	Guide Rod Eyelet	19, 20
C	Baseplate Release Lever	11
D	Depth Stop Turret	8, 10
E	Turret Latching Lever	8, 10
F	Depth Stop Post	8, 10
G	Depth Stop Locking Lever	8, 10
H	Depth Stop Post Handle	8, 10
I	Fine Adjustment Dial	8, 10
J	Speed Control Dial	7

Item	Name or Description	Ref. Page(s)
K	Ratcheting Spindle Lock	9
L	Collet	9
M	Handle	12
N	Trigger Lock	7
O	Power Trigger	7
P	Dust Shroud Release Lever	7
Q	Dust Shroud	7
R	Plunge Lock Knob	8, 10, 12
S	Dust Collection Port	7

Power Controls



To operate the router:

1. Set the motor speed by turning the variable speed control knob to the desired speed according to the router speed settings table below.
2. Start the router by pulling in on the power trigger.
3. If desired, lock the power trigger in the On position by holding in the trigger lock button, and then release the power trigger.
4. To release the trigger lock, pull in and then release the power trigger.

Router Speed and Feed Rate

The optimal router speed for an operation is determined by the diameter of the router bit and the type of material being machined. The important factor is the speed that the router bit tips move past the workpiece. The tip speed is proportional to the diameter of the router bit.

If the tip speed is too high, friction causes excessive heat and the workpiece can be scorched. Too low of a tip speed and the bit will tear the material instead of cutting (for aluminum, the bit will grab the workpiece).

The feed rate of the router past the workpiece is a function of the router speed, material type, and amount of material being removed. Too fast of a feed rate can cause chatter and tearout. Too slow of a feed rate can burn or scorch the workpiece.

Material	Router Speed Settings					Feed
	Bit Diameter (inches)					
	≤1/2	3/4	1	1 1/4	≥1 1/2	
Pine	5-6	5-6	4-6	3-5	3-5	Fast
Oak	5-6	4-6	4-5	3-5	2-4	Moderate
Cherry	3-5	3-5	3-4	2-4	2-3	Moderate
Maple	3-5	3-5	3-4	2-4	2-3	Slow
Particleboard and MDF	5-6	5-6	4-6	3-5	3-5	Fast
Soft Plastics	3-5	3-5	3-4	2-4	1-3	Slow
Hard Plastics	2-4	1-4	1-3	1-2	1-2	Slow
Aluminum	3-4	3-4	2-3	2-3	1-3	Slow

Dust Collection

i The OF2200 router can be connected to the power outlet of a Festool CT-class dust extractor, however, the more load that is on the router, the more power it will draw. If the router is drawing nearly its full load power, it may be necessary to connect the router to a separate electrical circuit from the dust extractor to prevent the electrical circuit from being overloaded.

i When routing plastics there may be a significant buildup of static charge in the material and the router. To minimize the nuisance static shocks, it is best to use an anti-static dust extractor hose.

The OF2200 router was designed to have excellent dust collection capabilities. The integral dust collection port extracts dust right at the point of generation—near the router bit. The retractable dust shroud helps prevent dust from escaping the work area, and the optional chip deflector helps capture dust while edge routing.

The dust shroud is spring loaded and latches in the retracted position. To raise the shroud, lift it up until it clicks into position. To lower the shroud, press the release lever.

To use the Chip Deflector, refer to the [“Installing Template Guides”](#) section on page 11.



Plunge Components

Depth Stop Turret

The depth stop turret has four positions, each with a different height, or offset from the base position. The desired final routing depth is set for the base position, and the four offset positions allow for incremental depths to reach the final depth. The 2mm offset position is used to provide for a final cleanup pass. The first adjustable offset allows for a 6 to 18 mm range and the upper adjustable offset allows for a 18 to 51 mm range.

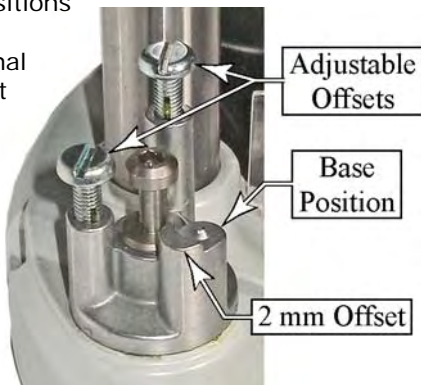

Turret Latching Lever

The turret latching lever locks the depth stop post to the center pin of the turret when the turret is in the Base Position. This permits the router height to be controlled by the Fine Adjustment Dial (see below) and the router to remain in the plunged position without the plunge lock engaged.

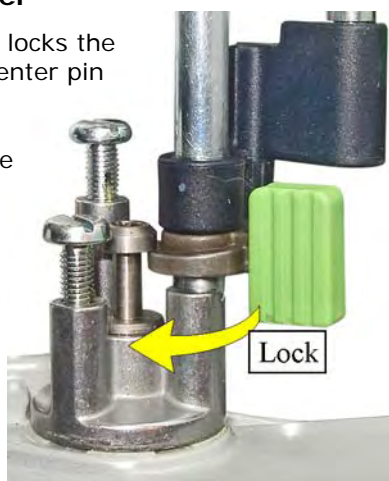

Fine Adjustment Dial

The fine adjustment dial raises and lowers the depth stop post for making very precise depth setting changes. Each click of the dial represents a 0.1 mm change, and a full rotation is equal to 1.0 mm.

The index ring can be rotated separately to zero out the index numbers at a starting point to make it easier to determine changes in height.



Plunge Depth Gauge

The plunge depth gauge shows the position of the depth stop post. When the index pointer is reset to zero at a depth position, the gauge will show the change in depth as the depth stop post is raised.

One example of this is to use the surface of a workpiece as the zero point, and then use the gauge to set the depth of the cut below the surface. This is described on page 10.

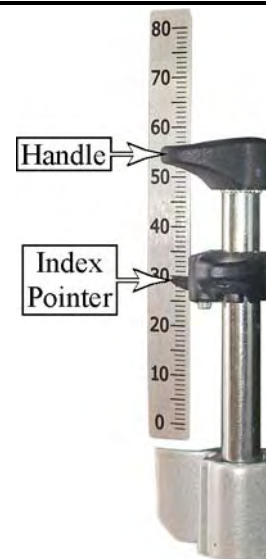

Plunge Lock Knob

The plunge lock knob locks the router in a plunged position. To lock the plunge, rotate the knob counterclockwise. To unlock the plunge, turn the knob clockwise.

Note that the plunge lock needs to be released while using the Turret Latching Lever and fine adjustment dial.

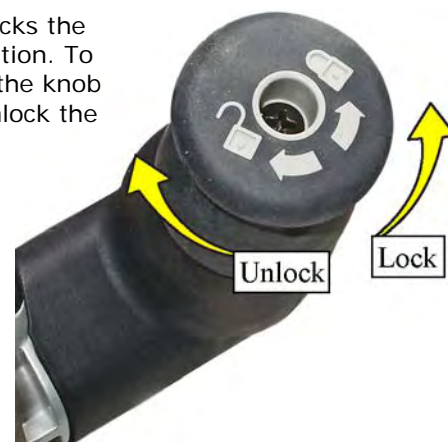

Depth Stop Locking Lever and Post

The depth stop locking lever clamps down on the depth stop post to keep it from moving. The locking lever is located on the fine adjustment cylinder, so that fine adjustments can still be made when the post is clamped. To engage the lock, turn the handle clockwise, and to release the lock, turn the handle counterclockwise.

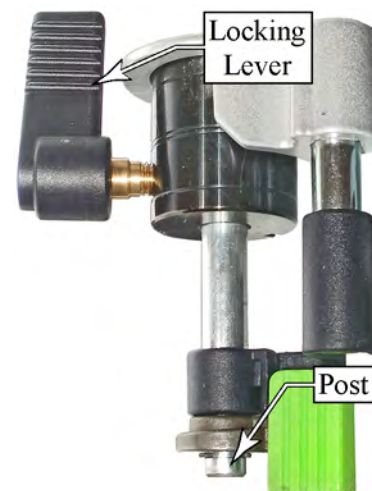

Basic Operation

Changing Router Bits

The OF 2200 EB has the unique feature of a ratcheting spindle lock. Because the spindle lock is ratcheted, you don't need to remove the wrench to make multiple turns of the collet nut; simply move the wrench back and forth.

The router also has an extremely deep spindle bore (3 ½ inches/89 mm). Very few router bits are long enough to bottom out in the spindle. This is important, because if a router bit is inserted so deep into the spindle that it touches the bottom, the collet will not tighten properly and the bit can come loose. The router bit gripping surface of the collet is approximately 1 inch deep (shown below).



WARNING! To reduce the risk of injury, unplug the router before changing the router bit.

1. Insert the router bit into the collet at least one inch. This will vary with different bits, but most of the shank should be within the collet.
2. Place the collet wrench on the collet nut.
3. Press the left-hand side of the spindle lock.
4. Tighten the collet nut firmly, but it is not necessary to over tighten the nut.
5. Remove the wrench from the collet nut before starting the router.



WARNING! To reduce the risk of injury, never operate the router without properly securing the router bit in the collet.

Changing Collets

The router can use a variety of router bits with different shank diameters by changing the collet. The router can use 1/4-in., 3/8-in., 1/2-in., and 8mm collets. The collet is integral with the collet nut, so unscrewing the collet nut will pull the collet out of the tapered spindle.

To change collets, unscrew the existing collet all the way out of the spindle and screw the new collet into the spindle.



Avoid leaving a router bit installed in the collet for long periods of time (during storage), because the bit and collet can stick together and be difficult to separate. Refer to the [Maintenance](#) section on page 23 for collet maintenance.

6. To remove a router bit, follow the same procedure except press the right-hand side of the spindle lock.



NOTICE: Do not tighten the collet nut without a router bit in the collet. Doing so will distort the collet.

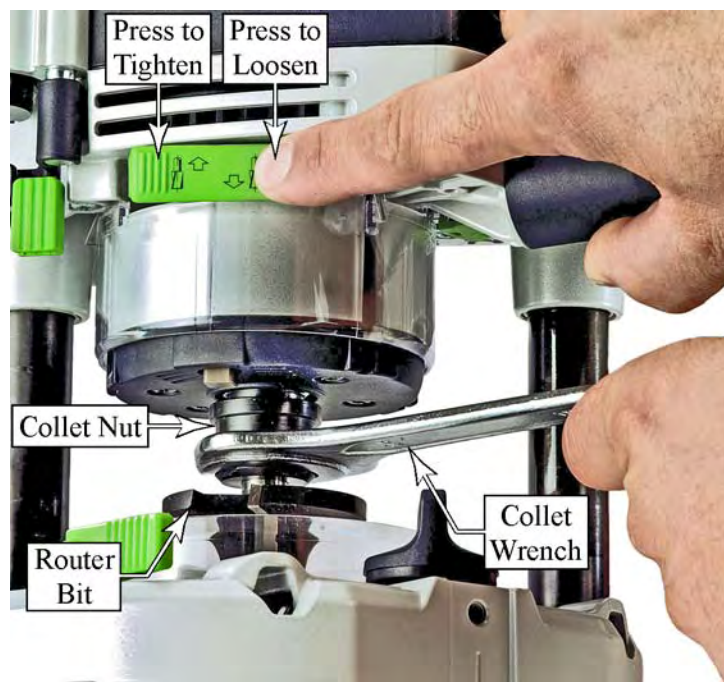

The collet is held into the collet nut with an O-ring. The collet can be separated from the collet nut only when there is no router bit in the collet. If you inadvertently separate the collet from the nut, press the collet into the nut until it snaps in position, and then gently pack the O-ring in between the collet and the nut with a small, blunt tool. Avoid removing the collet from the nut, except for maintenance.

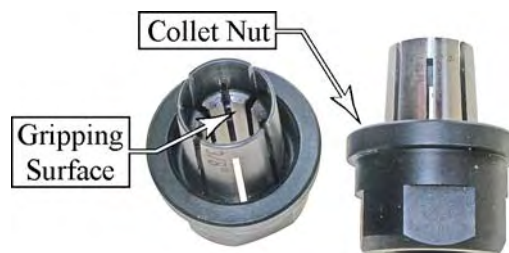

Setting the Plunge Depth

Offset from a Surface

Setting the plunge depth as an offset from a surface is used when making plough or dado cuts at a specific depth below the surface of the workpiece.

Refer to the [Plunge Components](#) descriptions on page 8.

1. Unplug the router for safety.
2. Rotate the turret to the base position.
3. With the plunge lock knob released, gently plunge the router until the router bit touches the surface of the workpiece, and retighten the plunge lock knob.
4. Loosen the depth stop lock lever and lower the post until it rests on the turret base position.
5. Slide the index pointer down to the zero position.
6. Raise the depth stop post until the index pointer is pointing the desired plunge depth, and tighten the depth stop lock lever.

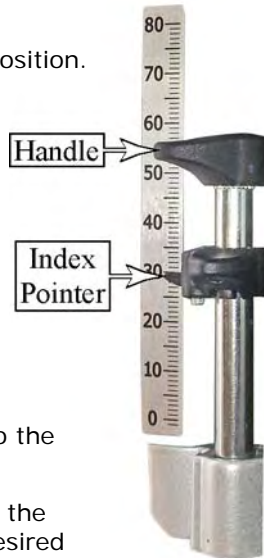

7. If desired, you may use the fine adjustment dial to fine tune the setting.
 - ▶ The resulting gap between the depth stop post and the turret represents the depth below the surface that the router will plunge to.
8. Release the plunge lock knob and raise the router to its normal position.
9. Operate the router as described in the "[Basic Operation](#)" section on page 9.

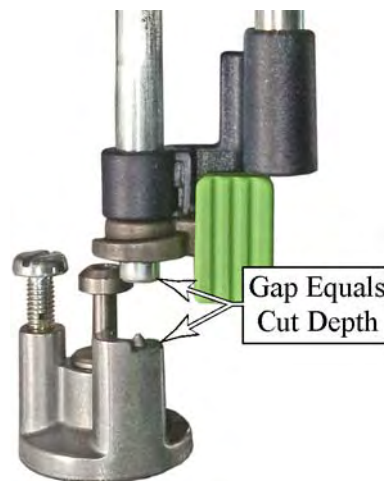

By Router Bit Profile

Normally, setting the depth of a plunge router based on the profile of the router bit can be problematic. However, the [Turret Latching Lever](#) (page 8) makes the task easy.



WARNING! To reduce the risk of injury, unplug the router when working near an exposed router bit.

1. Rotate the turret to the Base Position.
2. Loosen the depth stop locking lever and lower the post down to the Base Position on the turret.
3. Rotate the turret latching lever toward the turret to lock the post to the turret.
4. Plunge the router down to the approximate depth you wish for the bit profile, and tighten the depth stop locking lever.
5. Make sure that the [Plunge Lock Knob](#) (page 8) is released.
6. Lay a straightedge across the router's base for reference.

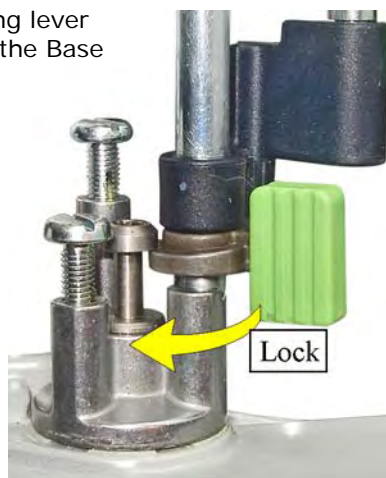

7. Use the [Fine Adjustment Dial](#) (page 8) to raise or lower the bit to the desired depth.
8. If a plunging action is required, then release the turret latching lever.
9. If a plunging action is not required, then engage the plunge lock knob. The plunge lock engages both plunge posts, and the router operation will be more stable.
10. Operate the router as described in the "[Basic Operation](#)" section on page 9.

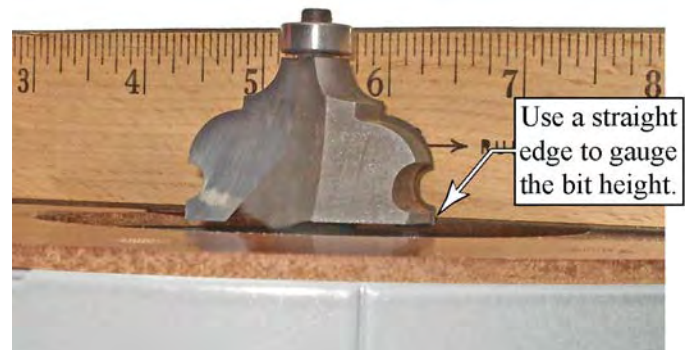

Changing Baseplates

A variety of optional baseplates are available for the router with a full range from narrow to wide openings. Router baseplates can be changed in seconds without needing any tools.



WARNING! To reduce the risk of injury, unplug the router when working near an exposed router bit.



Important: New baseplates, including the standard baseplate with the router, have a protective film covering the fiber-plastic base. This film should be removed before using the baseplate.

- ▶ To remove the baseplate, rotate the baseplate release lever.
- ▶ To install the baseplate, insert the hinge tabs into the slots at the back of the router and snap the baseplate closed.



Installing Template Guides and Chip Deflector

The **Chip Deflector** is used during edge routing to help contain flying chips and dust.

Template guides (also known as copy rings) are used to control the position of the router relative to an external pattern or template. This permits you to follow an external pattern even if the router bit does not have a guide bearing.

The OF 2200 EB router package may include either a standard Festool copy ring, a universal template guide adapter, or both. The template guide adapter allows you to use universal guides from other manufacturers with your Festool router.

The function of the Festool copy ring and the universal template guide adapter are the same, except with the universal guide adapter you provide the



template bushing. This allows you to use template guides that you already own with your Festool router.

To install the chip deflector or template guide, remove the baseplate and insert the deflector or guide in the center, and then reinstall the baseplate.



Basic Routing

Feed Direction Rules



WARNING! To reduce the risk of injury and loss of control, always be aware of the proper router feed direction. Except for special circumstances, the proper router feed direction is a Push-cut, and is described below.

Operating the router in the correct direction is important for maintaining control over the router. The standard feed direction for routing is that which opposes the cutter's rotation. This direction affords the operator the most control over the router feed speed. If the router is operated in the reverse direction, the router bit will tend to self-feed and propel the router down the workpiece at a high feed rate.

To make it easier to remember the standard and reverse feed directions, they are given descriptive names that describe the behavior of the router bit during the cut. These names are "**Push-cut**" for the standard direction, and "**Climb-cut**" for the reverse direction.

When making a push-cut, you are pushing the router against the router bit's rotation, and therefore, the router pushes back against your forward force. This is what gives you more control.

When making a climb-cut, the router bit wants to move in the same direction you are pushing, and if the bit suddenly grabs the wood, it can take off before you have a chance to pull it back. This can lead to a rapid loss of control. The term "Climb-cut" comes from the action where the router bit wants to "walk" or "climb" its way down the edge of the workpiece.

The general rule for basic routing is to always feed the router in the push-cut direction. Climb-cutting is an advanced routing technique and should be avoided by inexperienced

operators. This topic is briefly discussed in the [Advanced Routing Techniques](#) section on page 18.

Push-Cut Routing

Always feed the router against the rotation of the bit. This helps prevent the router from grabbing the wood and self-feeding, resulting in a loss of control.

- ▶ When routing around the exterior of a shape, feed the router counterclockwise (blue arrows shown below).
- ▶ When routing around the interior of a shape (such as the yellow arrows shown below), feed the router clockwise.
- ▶ To reduce tearout at the corners, begin routing across the end grain first (as indicated with "Start Here" in the figure below).

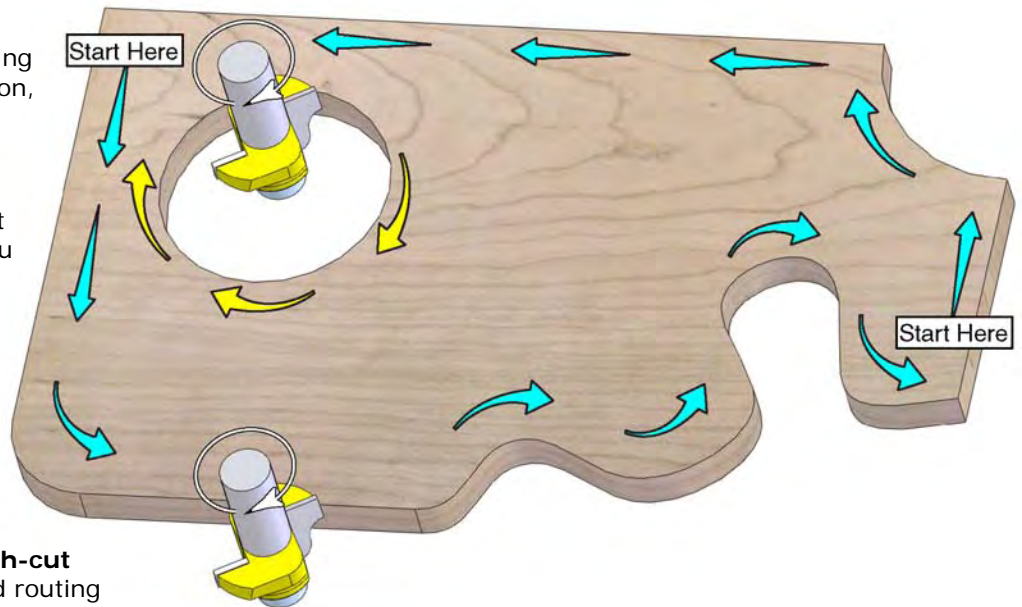

Fixed Depth Routing

Fixed depth routing is typically performed using router bits with a guide bearing that rides along the edge of a workpiece. The depth of cut is fixed before the router is engaged.

1. Verify that the router bit is properly secured, and the router is ready for operation.
2. Secure the workpiece to a stable surface.
3. Lower the router to the desired depth and tighten the plunge lock knob.
4. Set the router speed according to the speed settings table on page 13.
5. Place the router on the workpiece, and make sure the bit is not touching the wood.

6. Firmly grasp both handles of the router and pull in on the power switch.
7. Advance the router through the cut according to the feed direction rules below.



CAUTION: Starting the router with the bit in contact with the workpiece may cause a loss of control and injury.



Fixed Depth Using the Turret Latch



The turret latch can be used during fixed depth routing to provide an easy means for making small incremental changes in routing depth. An example of this is for inlaying a component or other piece of wood into a substrate wood, where the inlay needs to be perfectly flush with the substrate surface. The depth of the cut can be finely adjusted and the component test-fitted between passes (refer to the example on page 16).

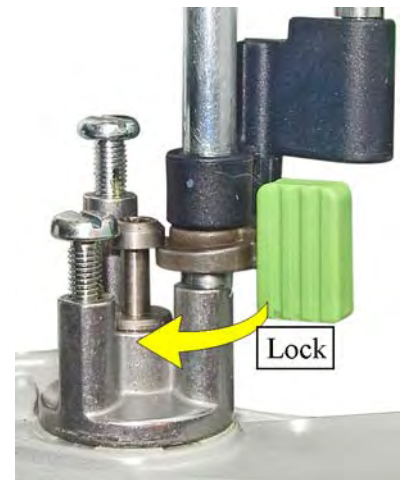

Plunge Routing

Plunge routing is any operation where the router is lowered down into the cutting area after the router has been started. Most often this involves router bits that do not have a guide bearing, but can also be used for interior cutting (such as the circular cut shown on page 13).

1. Verify that the router bit is properly secured and the router is ready for operation.
2. Secure the workpiece to a stable surface.
3. Set the router speed according to the speed settings table on page 7.
4. With the router turned off, place the router on the workpiece.
5. Firmly grasp both handles of the router and pull in on the power trigger switch.
6. Lower the router to the desired depth, tighten the plunge lock knob, and advance the router through the cut.

- ▶ For router bits with guide bearings, advance the router through the cut according to the feed direction rules discussed on page 13.
- ▶ When using router bits without a guide bearing, or with an external guide rail, follow the tips in "plough cuts" below to keep the router tracking properly.



i Note: Failure to tighten the plunge lock knob may result in the router depth rising unexpectedly.

Plough Cuts

When making plough cuts, as shown to the right, three sides of the router bit are engaging the workpiece. This can lead to undesired changes in the path of the router.

- ▶ One side of the router bit is climb-cutting, and this tends to propel the router forward.
- ▶ One side of the router bit is push-cutting, and this tends to slow the feed rate.
- ▶ The leading edge of the router bit pushes the router sideways, opposite the rotation of the bit.

The opposing climb-cutting and push-cutting sides may cause the router to advance with a jerking motion.

To avoid drift from the leading edge of the router bit, position a guide rail on the push-cutting side of the router (toward the middle in the image to the right).

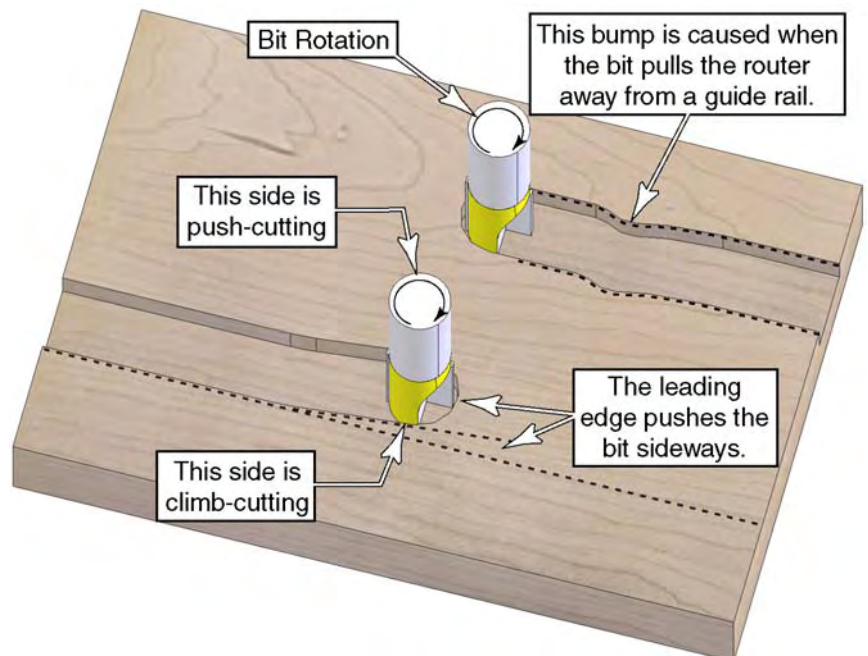

Using a Template Guide

- ▶ To install the template guide to the router base, follow the procedure described on page 11.
- ▶ Template guides are available with a variety of bushing diameters. Typically, the bushing diameter should be slightly larger than the router bit diameter, but never so close that the router bit can contact the interior of the bushing.



NOTICE: If the spinning router bit contacts the interior of the template guide, it will damage both the router bit and the guide.

- ▶ The routing pattern needs to be smaller than the desired routed edge as shown in both images to the right.
- ▶ The offset between the pattern and the final routed edge is $\frac{1}{2}$ the difference between the template guide bushing diameter and the router bit diameter (shown in both images to the right).

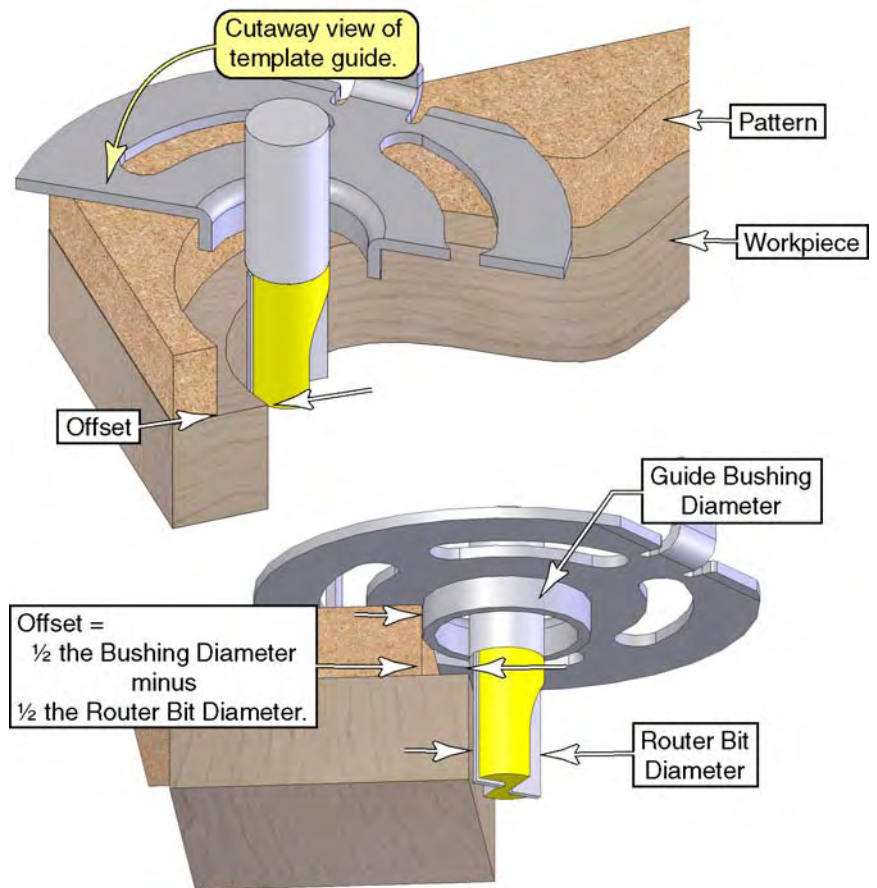

Advanced Routing Techniques

Multi-pass Cuts

Nearly all routing operations can be improved by making multiple passes. In some cases the routing operation would remove too much material to be completed safely in a single pass. In other cases, the finished cut is

improved by making a shallow, clean-up pass. Some multi-pass cuts are made by varying the depth, and others are made by varying the position. The different types are shown below.

Multi-depth Ploughing

When ploughing out large volumes of material or making deep dados, make the cuts using successively deeper settings until the final depth is reached. The four positions of the depth stop turret are well suited for this type of operation.

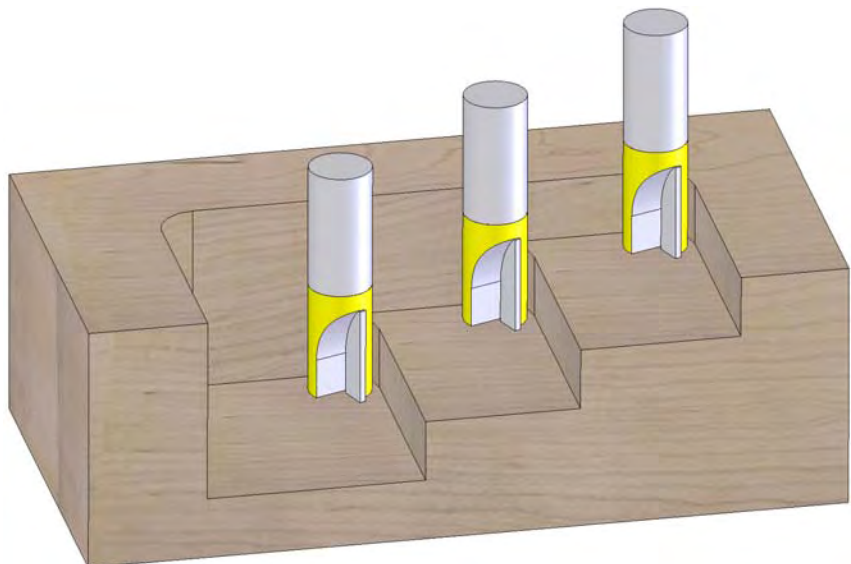

Multi-depth Profiles

There are several reasons for making multiple passes with edge forming, profile cutters.

- ▶ For large profiles, a shallow first-pass can be made to remove the bulk of the material.
- ▶ Several shallow passes can be made for better control with large router bits.
- ▶ A final, shallow, clean-up pass can improve the quality of the finished edge.

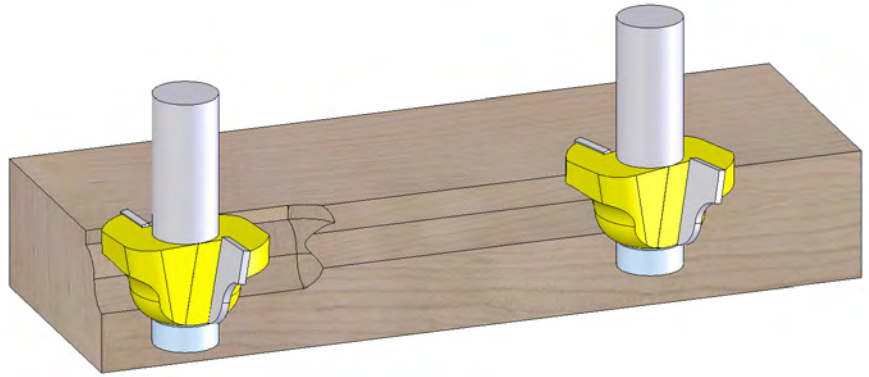

Multi-position (horizontal) Profiles

Altering the horizontal position of a router cut for multiple passes is required whenever the profile cuts back into the workpiece in a way that changing the depth would destroy the desired profile. A common example of this is a slot cutter. A common problem with this type of cutter is that sharp corners between the cut profile and the uncut wood edge will tend to tear out. This can be reduced by making a very shallow scoring cut before making a full profile cut.

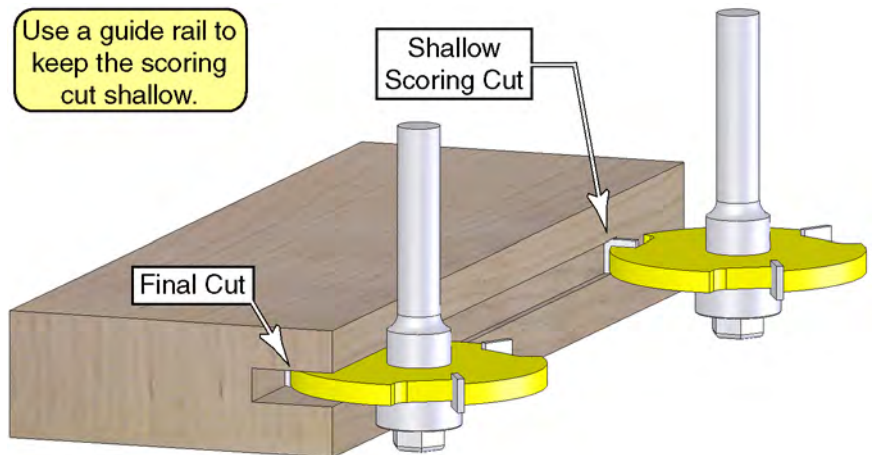

Pre-cutting Dovetails and Keyways

Dovetail and keyway cutters are inherently weak because the upper shank of the bit is smaller than the cutting edges. If the stress on the bit is too great, the cutting tip can break. To reduce the stress on the cutter, it is common practice to plough out the majority of the material with a straight bit. The depth of the straight bit should be slightly shallower than the depth of the final bit so the bottom of the profile remains square.

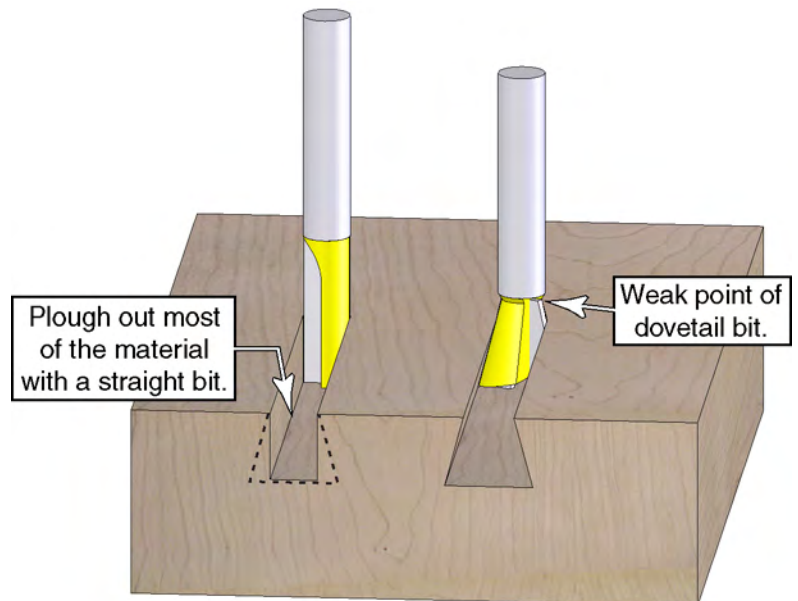

Precision Routing

There are many applications where precision routing is required, such as template routing, dados, fluting, and inlays. Inlaying a secondary component, such as hardware, into an existing substrate is typically where the greatest level of precision is required. In the example below, both the width of cut and depth of cut need to be precisely controlled for the component to fit tightly into the dado and flush with the surface.

There are many methods for controlling the size (width in this example) of a cutout. A template system such as the MFS guide (shown on page 13) is very effective for making multiple copies of the same cut. For this example, the guide rail attachment is used because it permits fine adjustment to ease the cut to the exact size through test-fitting.

Hardware Inlay Example using the Turret Latch

The primary basis for this example is using the turret latch and fine adjustment dial to precisely control the depth of cut for a multi-pass dado to inlay a component at a precise depth, such as flush to the surface.

- ▶ If you do not have a router bit that is the exact width of the component to be inlaid, then use a router bit that is slightly narrower than the desired final cut, and make progressively wider cuts by shifting the router.
- ▶ Set up the [Guide Rail Attachment](#) as described on page 19, and also shown to the right.
- ▶ Set the router position so the bit is cutting along one side the desired cut. You can make a shallow pass to verify the initial position and fine-tune the position as described in the [Guide Rail Attachment](#) procedure on page 19.
- ▶ Engage the [Turret Latching Lever](#) and set the initial depth of the bit as described in the [Setting the Plunge Depth](#) procedure on page 10, but make sure the initial depth is slightly shallower than the final depth.
- ▶ Gradually increase the router's horizontal position (width of the cut) using the fine adjustment dial on the guide rail attachment until the component fits into the width of the cutout.
- ▶ Using the fine adjustment dial on the top of the router and the fine adjustment dial on the guide rail attachment, gradually increase the depth of the cut and clean up the width until the component fits to the desired depth (flush with the surface in this example).

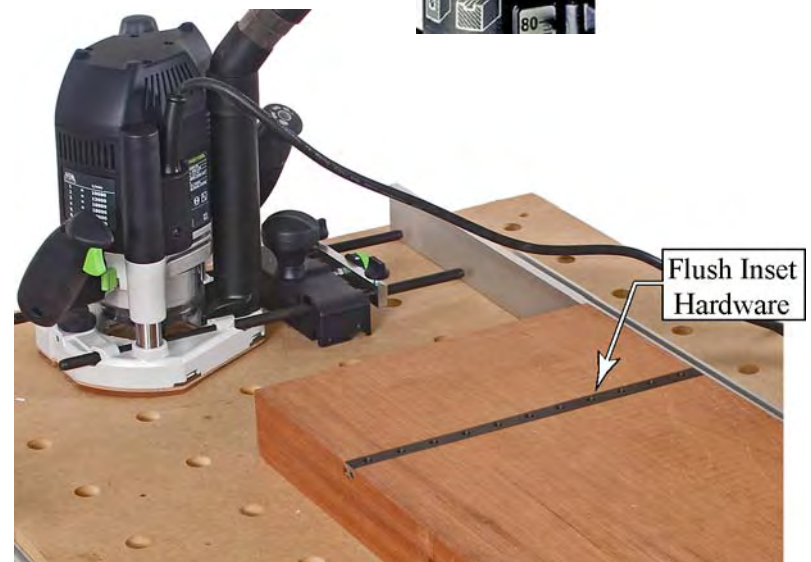
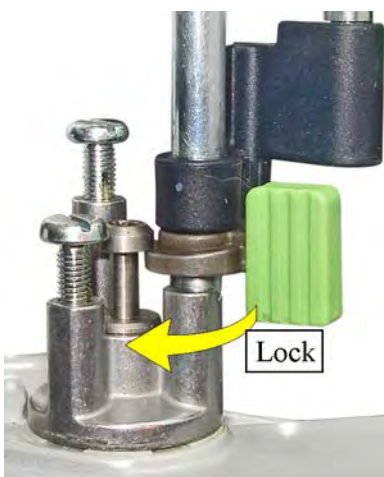
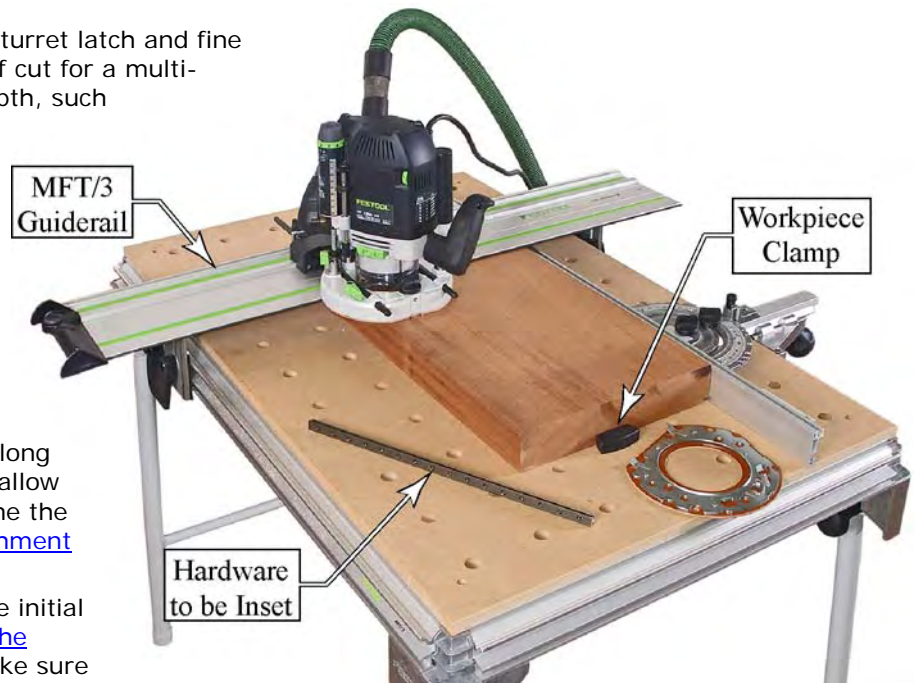

Tips for Successful Routing

Chipping and Tearout

One of the most common problems woodworkers will encounter when using a router is chipping and tearout of the workpiece. The following tips can reduce the occurrence of chipping and tearout.

- ▶ Take shallower passes to reach your final depth. With a shallow pass, the router bit teeth will be cutting parallel with the grain instead of arching through the grain.
- ▶ Examine the woodgrain before routing. If possible, orient the workpiece so the grain doesn't fracture. To identify the grain orientation, examine the edge grain, not the surface grain. Use the following tips:
 - ▶ If the grain orientation is not in the right direction, turn the board over. (Rotating the board to the opposite edge does not change the orientation. You must flip the board over.)
 - ▶ For tight-grained woods where the grain orientation is not obvious, look for pre-existing signs, such as small splinters at the corners. You can also use a knife to cleave the grain.

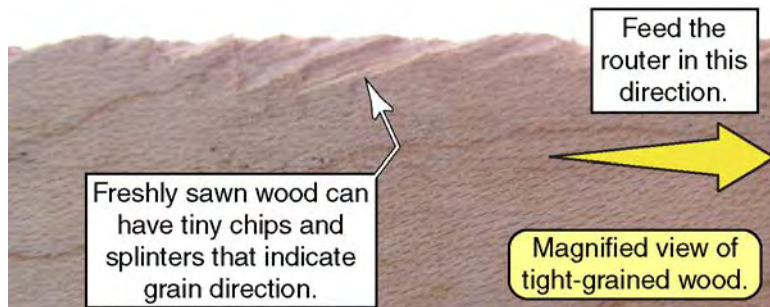

- ▶ For open pore woods such as oak, examine the capillaries on the edge of the wood. Orient the board so the router is moving away from the capillary entrance holes.

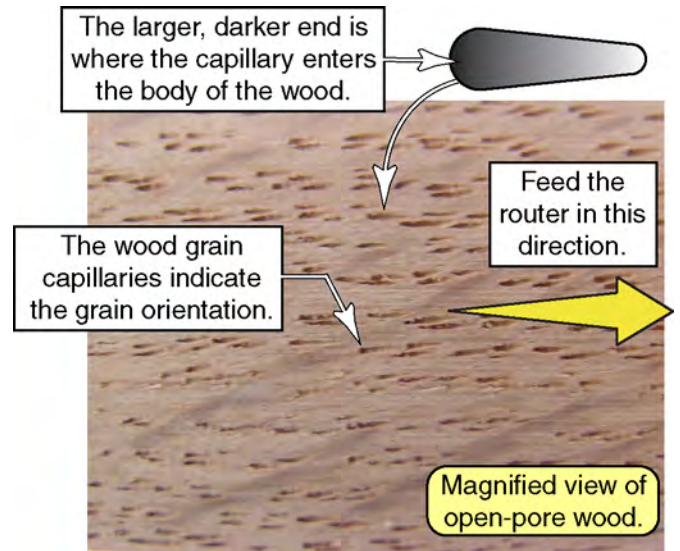

Chatter

Router bit chatter is the presence of small curves, or scallops, in the routed profile. The following items may cause chatter:

- ▶ Too fast of a feed rate for the router RPM.
- ▶ Trying to take too much material in a single pass.
- ▶ Climb-cutting.
- ▶ The smaller the diameter of the router bit, the more prominent or noticeable the chatter will be.

If chatter is present in the routed profile, making a low-speed cleanup pass typically removes the marks.

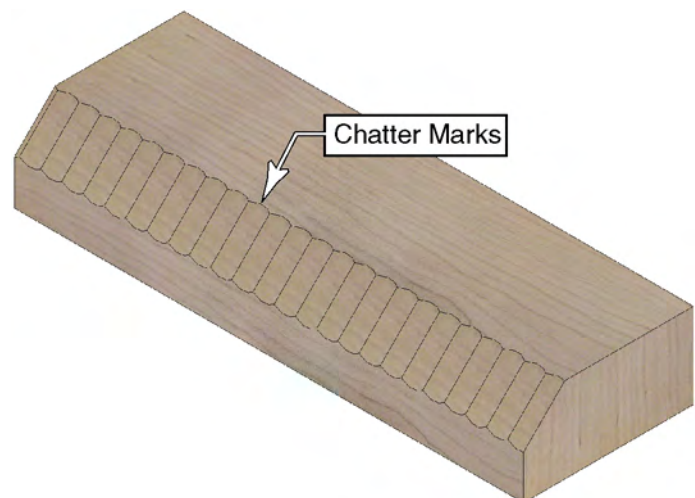



Climb-Cut Routing

 **WARNING:** Climb-cutting with a router increases the risk of serious injury. The router bit may grab the workpiece, leading to a loss of control. Read, understand, and follow all of the warning messages below.

 **WARNING:** There is no safe method for climb-cutting. The router bit can grab the workpiece at any time, resulting in a loss of control.

 **WARNING:** Never attempt climb-cutting with large diameter bits. The larger the bit, the more likely it will grab the workpiece.

 **WARNING:** Never, under any circumstances, attempt to climb-cut with a table-mounted router. The workpiece **will** catch and **will** be propelled off the table.

 **WARNING:** Never climb-cut around an interior cutout in a workpiece. The bit can easily catch in the corners.

 **WARNING:** The workpiece must be fully secured in place with clamping devices. Friction mats are not sufficient for securing a workpiece during climb-cutting.

 **Disclaimer:** Festool does not condone the practice of climb-cutting with a router. This topic is presented for information only, and is intended to warn the user of the potential risks of climb-cutting. The information below does not explain how to perform climb-cutting, but instead, explains what not to do. Any user attempting climb-cutting, does so at their own risk.

What is Climb-Cutting

Climb-cutting is feeding the router in the same direction as the rotation of the bit. The inherent danger is that the router bit will tend to self-feed, or "climb" its way down the workpiece. The sole benefit for climb-cutting is that there will be less tearout in the cut. This is because the tip of the cutter enters the edge of the workpiece, instead of exiting the edge of the workpiece. This shears the wood fibers in a compressing action, and results in less tearout.

Aside from the increased risk for loss of control, a drawback to climb-cutting is that the router bit will tend to push the router away from the edge of the workpiece. This can have two consequences regarding the quality of the cut. First, the router will not cut as deeply as expected. Secondly, the routed profile will tend to have a scalloped surface, called chatter. To overcome these conditions, it is typically necessary to make a second, clean-up pass across the cut. This second pass can be either in the climb-cut or push-cut direction, at the operator's discretion.

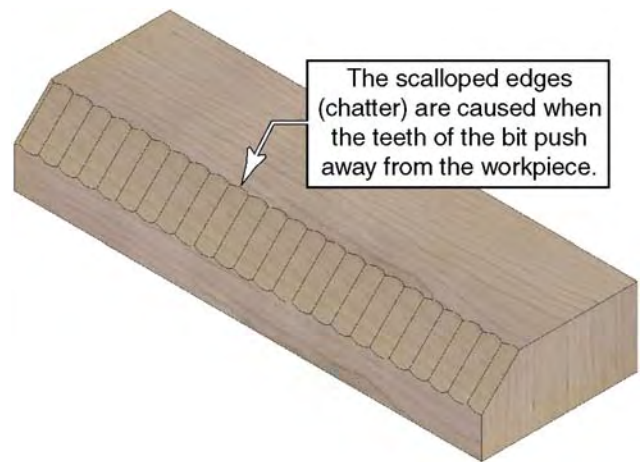
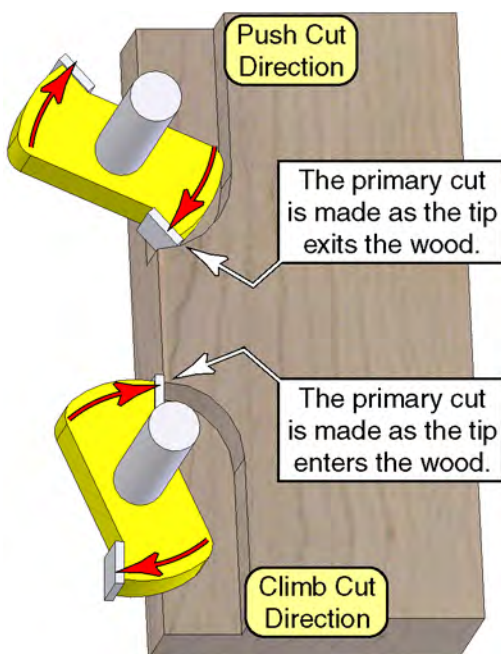

Notes

- ▶ Never let your guard down. Always be expecting the router to catch, and think ahead of how you should best react to the situation before it happens.
- ▶ As with any power tool, respect the danger, but do not operate the tool if you are afraid of the operation. Your reactions will be diminished if you are afraid of the tool or the procedure.
- ▶ Instead of relying on your reaction-time to control the router feed rate, use friction. By holding your forearm (while grasping the router handle) firmly to the workpiece you use friction to assist in keeping the router under control.
- ▶ Avoid climb-cutting with the router moving toward your body. More control is possible with the router pulling away from your body with your arms outstretched.
- ▶ Use a push-cut for end grain. Climb-cutting end grain does not improve the cut quality. The wood fibers are torn and compressed, and the result is a rougher finish.
- ▶ For materials that are prone to burning (such as cherry and maple) climb-cutting reduces burning because the primary cut is shearing the fibers.
- ▶ Make multiple shallow passes when feasible.
- ▶ In most cases, a final cleanup pass in the push-cut direction results in the best finish.

Accessories

Guide Rail Attachment

The guide rail attachment is used to connect the router to a Festool guide rail system for making guided straight cuts with the rail controlling the router position.

1. Before assembling the guide rail attachment, adjust the guide rail gibs on the guide block. These keep the guide block straight on the rail.
 - a. Place the block on the rib of the guide rail.
 - b. Tighten the two adjustment screws until the block fits snugly to the rib without wiggling, but still moves freely.

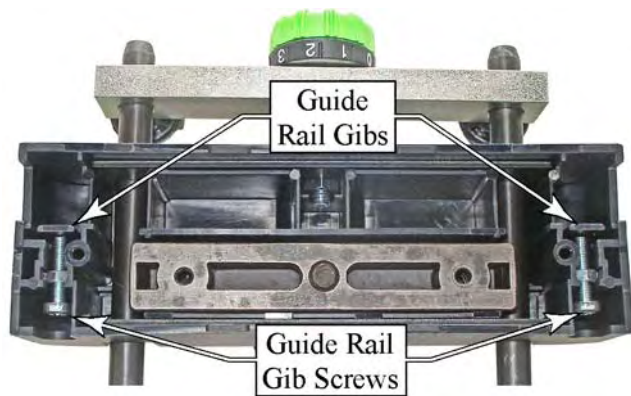

2. Install the guide rail baseplate on the router (see page 11). The elevated foot plate compensates for the thickness of the guide rail to keep the router flat.

3. Insert the two guide rods through the guide block and into the clamping bar. Make sure the rods stick out from the clamping bar slightly, as shown.

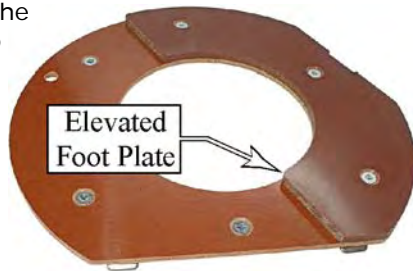

4. Tighten the two guide rod thumbscrews.

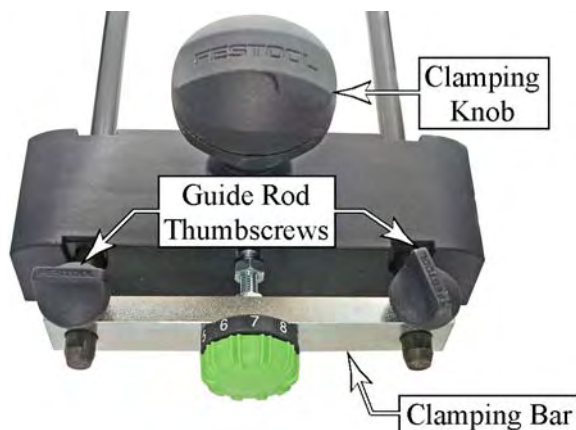

5. Insert the guide rods through the eyelets in the router base.
6. Place the router on the guide rail, and adjust the router in or out as needed. Make sure the router bit does not cut the guide rail or splinter guard.



The splinter guard on the guide rail is used for sawing operations, and should not be used for routing operations. Make sure the router bit does not cut into the splinter guard.

7. Tighten the guide rail clamping knob on the router.

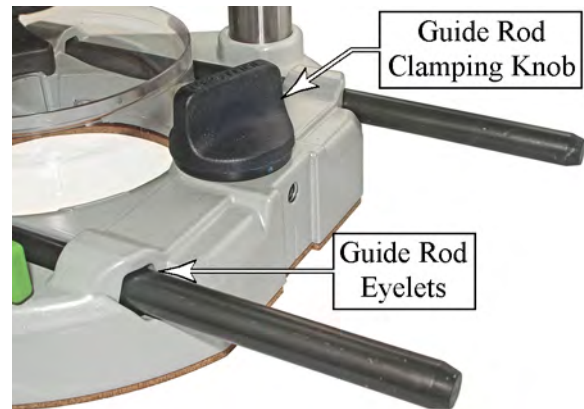

8. Fine tune the router's position by turning the fine adjustment dial.
9. When the lateral position is correct, tighten the guide block clamping knob.
10. Before starting the router, make sure that all clamping knobs and devices are secured.
11. Operate the router as described in the applicable section(s) under [Basic Operation](#) beginning on page 9.

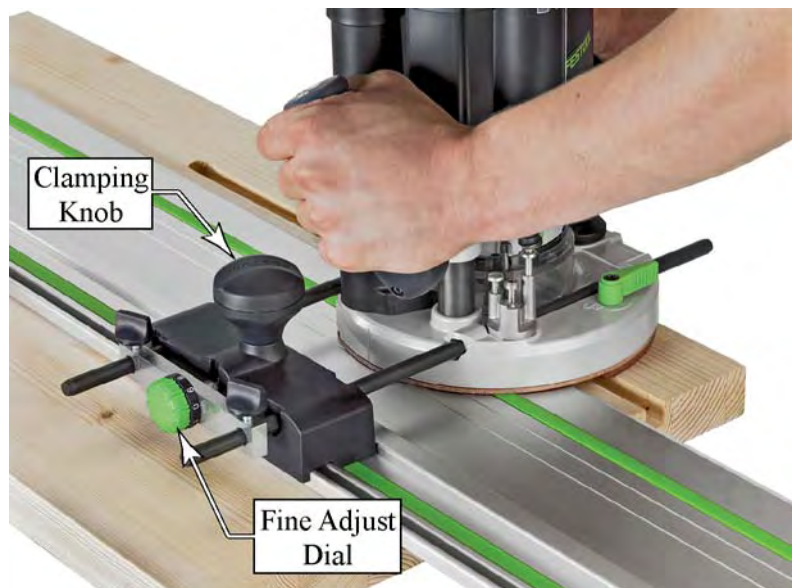

Edge Guide

The edge guide is used for guiding the router relative to the edge of a workpiece. This can be used for interior plunge routing (such as fluted columns) or for edge

forming. While the operations are similar, there are additional setups necessary for edge form routing.

Edge Forming Setup

When using the edge guide for edge forming, the router bit will be within the cutout of the edge guide (as shown to the right).

- ▶ The two fence plates need to be separated enough to clear the router bit so the bit does not cut the fence.
 - ▶ There are three options for dust collection. The standard dust extraction shroud may be used (see page 7), the optional dust chute may be attached to the underside of the edge guide, or both dust extraction options may also be used together (this would require two vacuum hoses).
1. Loosen the four mounting screws on the fence plates and slide the plates apart enough to clear the router bit.
 2. Retighten the mounting screws.
 3. If desired, slide the dust chute under the mounting tabs until it clicks into place.

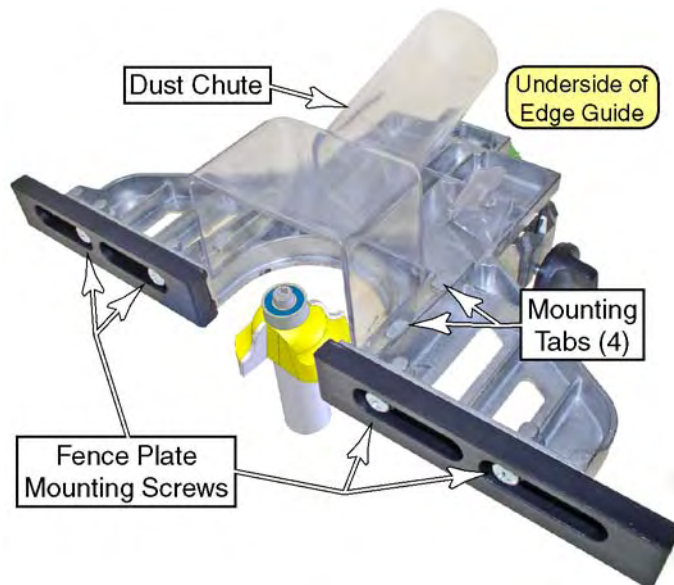

General Setup

The same general setup is used for both interior and edge form routing. The image to the right shows an edge forming setup.

1. Insert the guide rods through the edge guide as shown, and tighten the Guide Rod Thumbscrews.
2. Insert the other end of the guide rods through the eyelets in the router base.
3. Set the approximate position of the router, and tighten the Guide Rod Clamping Knob on the router base.
4. To set the final position of the router using the fine adjust feature:
 - a. Loosen the Fine Adjust Clamping Knob on the edge guide.
 - b. Turn the Fine Adjust Dial to set the position of the router.
 - ▶ Turning the dial toward increasing numbers moves the router away from the edge guide.
 - ▶ Each number represents 0.1 mm, and a full revolution is equal to 1.0 mm.
 - c. Retighten the Fine Adjust Clamping Knob knob.

5. Make sure you operate the router from left to right to keep the edge guide tight to the workpiece. (Refer to the discussion on "[Plough Cuts](#)" on page 13 and "[Feed Direction Rules](#)" on page 12.)

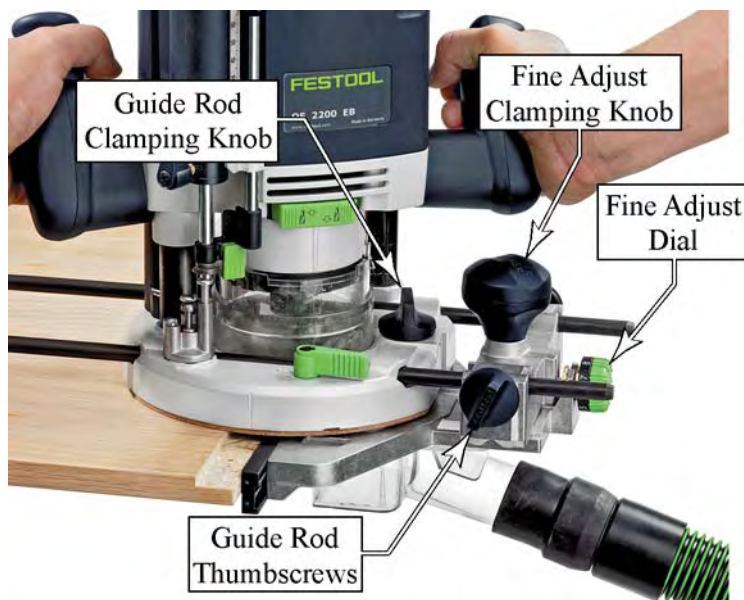

Systainer (System Container)

Most Festool hand tools and many accessory kits are shipped in their own unique system container, called a "Systainer". This provides protection and storage for the tool and accessories. All Systainers are stackable and can be interlocked together, including stacking and locking atop Festool dust extractors.



Parts of the Systainer

- ▶ **Carrying Handle.** The carrying handle folds flat when not in use.
- ▶ **Cover Latches.** The two green latches on the front of the Systainer secure the cover. (These are also used for stacking Systainers, as described below.)
- ▶ **Stacking Latches.** The two gray latches on the sides of the Systainer are used for stacking one or more Systainers together.
- ▶ **Stacking Tabs.** The stacking tabs are used to lock two Systainers together. There are four sets of tabs (two on the front and two on the sides) of each Systainer.

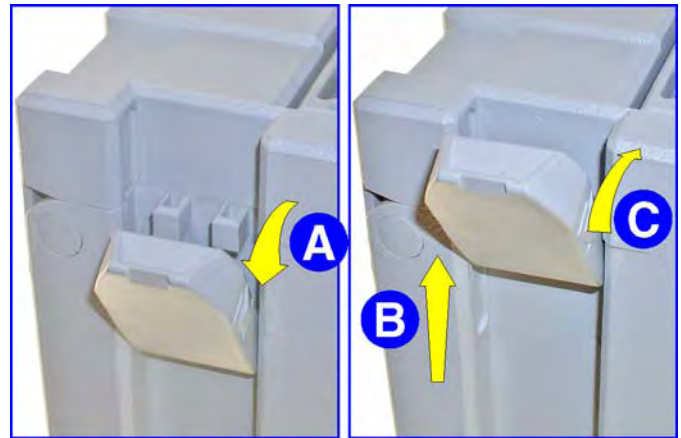

Stacking Systainers

For convenience in transporting Festool tools and accessories, the Systainers can be stacked and locked together. The Systainers are locked together using the stacking tabs and latches.

1. Place one Systainer on top of the other.
2. Release all four latches on the lower Systainer by pulling back at their top edges (step A to the right).
3. Slide all four latches upward (step B) as depicted by the two views.
4. Snap all four latches back to their flat position (step C) so they engage the stacking tabs of the upper Systainer.

The lower image to the right shows two accessory Systainers stacked together.



Troubleshooting

Symptom	Possible Causes
Motor does not start	<ul style="list-style-type: none">▶ Check that the cord is properly plugged into the router and into an outlet.▶ Make sure the outlet has power. Check the circuit breaker or try another outlet.▶ If used with a Festool dust extractor, make sure the selector switch is pointing to "Auto". The auxiliary outlet on the dust extractor has power only when the selector is at Auto.▶ Inspect the power cord (including extension cords) for damage or missing prongs, and replace as needed.▶ The motor brushes may have worn and need replacement.
Router does not plunge smoothly	<ul style="list-style-type: none">▶ Make sure the plunge lock knob is loose.▶ Clean the plunge posts (columns) and inspect for scratches and damage.
Router bits slip in the collet	<ul style="list-style-type: none">▶ The collet and mating arbor taper can become pitted from acids and oil in the wood. Clean the tapered surfaces:<ul style="list-style-type: none">a. Remove the collet from the router.b. Using a plastic scrubbing pad, clean the outer taper of the collet.c. Using a plastic scrubbing pad, clean the interior taper of the arbor.a. Make sure there is no plastic or metal debris left over from the cleaning, and reinsert the collet.▶ If router bits have spun inside the collet, it may be damaged and needs to be replaced.
Routed profile burns	<ul style="list-style-type: none">▶ The router bit is dull.▶ The router speed is too fast.▶ The feed speed is too slow.▶ Some materials are prone to burning. Take a shallow clean-up pass with a higher feed rate.▶ If the burn is below the profile, then the router bit guide bearing (if present) is worn.<ul style="list-style-type: none">▶ Remove the bit from the router and spin the bearing with your finger. If the bearing spins roughly, it needs replacement.▶ A good bearing should coast for about one revolution when spun with your finger. If it coasts more than one revolution, it is worn.▶ Replace the bearing or bit.
Router vibrates excessively	<ul style="list-style-type: none">▶ If a large diameter router bit is slightly out of balance, it will vibrate at high speed. Reduce the router speed. If the vibration is severe, discard the router bit.▶ The router bit shaft may be bent. Discard the bit if the shaft is bent.▶ The router bearings may be worn and need replacement.

Maintenance

Routine Maintenance

Any maintenance or repair work that requires opening of the motor housing must be carried out only by an authorized Customer Service Center (whose name is supplied by your dealer)! Maintenance or repair work carried out by an unauthorized person can lead to improper connection of electrical wires or other components, which can result in injury.



WARNING: To reduce the risk of injury or electrocution, always unplug the tool from the power supply outlet before performing any maintenance or repair work on the tool!

Do not use compressed air to clean the motor housing of the tool, as you could inject foreign objects into the motor through the ventilation openings. Compressed air may be used on other components, but personal safety protection should be employed (hearing, vision, and respiratory).

Certain cleaning agents and solvents are harmful to plastic parts. Some of these include, but are not limited to: Gasoline, Acetone, Methyl Ethyl Ketone (MEK), Carbonyl Chloride, cleaning solutions containing Chlorine, Ammonia, and household cleaners containing Ammonia.

To ensure proper cooling of the tool and motor, the cooling vents in the motor housing must always be kept clear and clean.

Keep the Tool Clean

Dust and debris from some materials can be extremely abrasive and cause components within the router to wear prematurely. It is important to keep moving parts cleared of abrasive dusts.

- ▶ As a general rule, keep the tool clean of all dust and debris. Even soft-wood dust can be abrasive over time.
- ▶ Examine all moving parts for dust and debris.
- ▶ Keep the plunge posts clean so dust does not get embedded into the bearing surfaces.

Keep the Router Bits Sharp



CAUTION: An improperly sharpened router bit can injure the operator, destroy the tool, and damage the workpiece.

Using a dull router bit can take more effort to cut and will cause poor cut quality.

- ▶ Never attempt to sharpen a router bit manually. Special equipment is necessary to properly sharpen any rotating-type cutter. Hand-sharpening can cause the bit to be out of balance.
- ▶ Your router bits should be sharpened regularly, and only by a qualified sharpening service.

Collet Maintenance

The collet and mating arbor taper can become pitted from acids and oil in the wood. Keeping the collet and arbor clean will make it easier to install and remove router bits. Clean the tapered surfaces of the collet and arbor:

1. Remove the collet from the router.
2. You may wish to remove the collet from the nut by tilting the collet until it snaps loose.
3. Using a plastic scrubbing pad, clean the interior taper of the arbor.
 - ▶ Very fine steel wool may be used, but make sure to clean up any remnant fibers afterward. These remnant fibers can rust or corrode and leave marks and pits in the metal surfaces.
4. Using a plastic scrubbing pad, clean the outer taper of the collet.
5. Make sure there is no plastic or metal debris left over from the cleaning.
6. If the collet was removed from the nut, snap the collet back into the nut, and then carefully pack the O-ring into the space between the collet and the nut.

If router bits have spun inside the collet, it may be damaged and needs to be replaced.

Adjust and Inspect the Tool

To ensure the tool is in proper working order, periodically inspect the operation of the tool and ensure it is properly adjusted.

- ▶ Observe the function of the router during normal operation.
- ▶ Unusual sounds are indicative of pending problems.
- ▶ A reduction in the cut quality indicates the router bit is dull or the router is not functioning properly.
- ▶ A reduction in cutting power or speed may indicate a dull cutter or a motor problem.

